

Data Sheet



Article number: 03441220

Description: Fluro Rod end GE 220EC-2RS

Measures

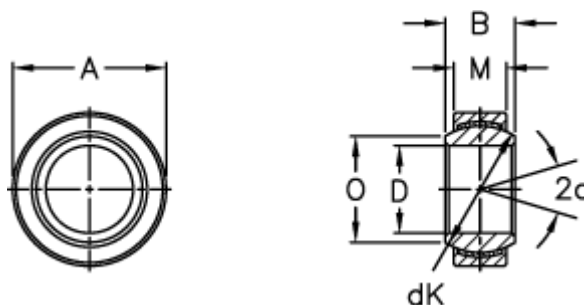

A = 320 0 -0,040

B = 135

D = 220 0 -0,030

dK = 275

Dynamic load C (kN) = 4400

M = 100

O = 239.5

Static load C0 (kN) = 8800

Tilt angle = 8

Weight = 35500